

BONALDO

Sleek

Designer: **Mauro Lipparini**



Sleek, dalla marcata sensibilità spaziale, rappresenta una nuova idea di comfort ed estetica, capace di interpretare dinamicamente le esigenze di chi la vive. La forma di questa poltrona elegante disegnata da Mauro Lipparini, tra tagli discreti e geometrie armoniose, ci riporta allo spirito nostalgico del modernismo mid-

century italiano. Il monovolume della seduta-schienale poggia su una struttura in metallo dal design fisionomicamente e visivamente leggero. La poltrona Sleek è disponibile sia nella versione girevole che in quella a quattro gambe.



Scheda tecnica

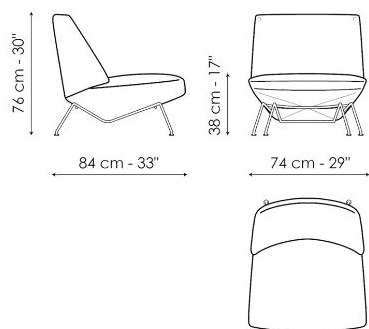

Sleek - piedi
Larghezza: 74cm
Profondità: 84cm
Altezza: 76cm

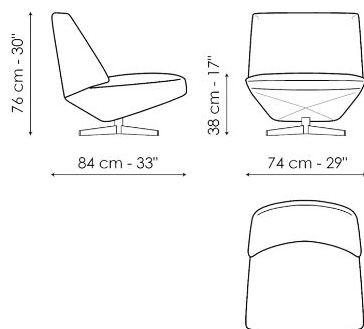

Sleek - base girevole
Larghezza: 74cm
Profondità: 84cm
Altezza: 76cm

Finishes

RIVESTIMNETO

Tessuto - 900



Tessuto - Azimut
9B02

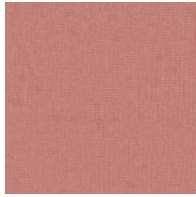

Tessuto - Azimut
9B08



Tessuto - Azimut
9B17



Tessuto - Azimut
9B22



Tessuto - Azimut
9B26

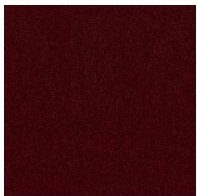

Tessuto - Azimut
9B36



Tessuto - Azimut
9B39



Tessuto - Azimut
9B42



Tessuto - Azimut
9B44

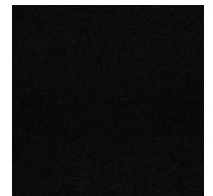

Tessuto - Azimut
9B48



Fabric - Newco
9B65

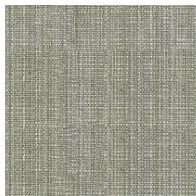

Fabric - Newco
9B66



Fabric - Newco
9B67



Fabric - Newco
9B68



Fabric - Newco
9B69



Fabric - Newco
9B70



Fabric - Newco
9B71



Fabric - Newco
9B72

Tessuto - Must



Tessuto - Boemian
MC40

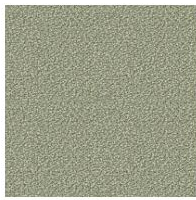

Tessuto - Boemian
MC43

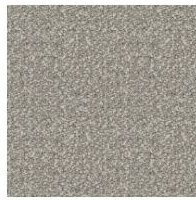

Tessuto - Boemian
MC46

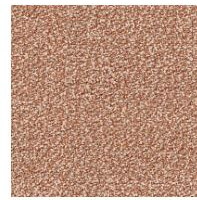

Tessuto - Boemian
MC47



Tessuto - Boemian
MC49



Tessuto - Rico
MA02

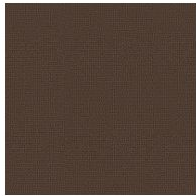

Tessuto - Rico
MA04

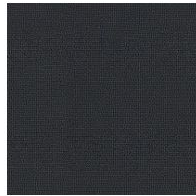

Tessuto - Rico
MA07



Tessuto - Rico
MA09



Tessuto - Rico
MA11



Tessuto - Rico
MA20

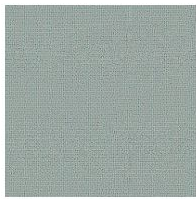

Tessuto - Rico
MA22

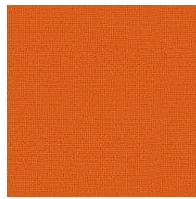

Tessuto - Rico
MC39



Tessuto - St. Moritz
MC60



Tessuto - St. Moritz
MC61



Tessuto - St. Moritz
MC62



Tessuto - St. Moritz
MC67



Tessuto - St. Moritz
MC69

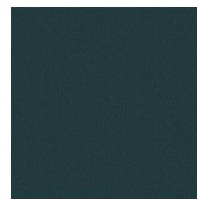

Tessuto - St. Moritz
MC76



Tessuto - St. Moritz
MC81



Tessuto - St. Moritz
MC83



Tessuto - St. Moritz
MC85



Tessuto - Flora
MD30



Tessuto - Flora
MD31



Tessuto - Flora
MD32



Tessuto - Flora
MD34

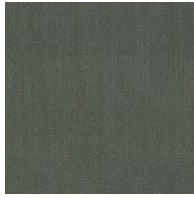

Tessuto - Flora
MD35



Tessuto - Flora
MD37



Tessuto - Flora
MD39



Tessuto - Nacchero
MD41



Tessuto - Nacchero
MD44



Tessuto - Nacchero
MD45

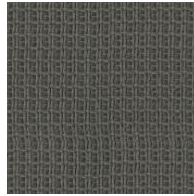

Tessuto - Nacchero
MD47



Tessuto - Nacchero
MD48



Fabric - Lucky
MD58



Fabric - Lucky
MD59



Fabric - Lucky
MD60



Fabric - Lucky
MD61

Tessuto - Special

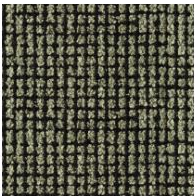

Tessuto - Brionne
SP19



Tessuto - Brionne
SP20



Tessuto - Brionne
SP21

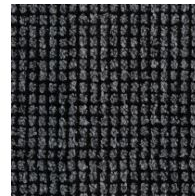

Tessuto - Brionne
SP22



Tessuto - Brionne
SP23

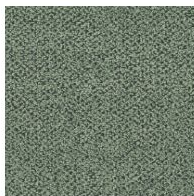

Tessuto - Rella
SP01

Tessuto - Rella
SP04



Tessuto - Rella
SP05

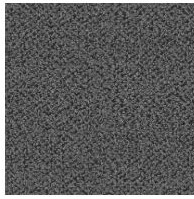

Tessuto - Rella
SP06

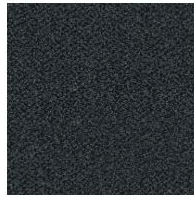

Tessuto - Rella
SP07



Tessuto - Diamon
Frisé
SP31



Tessuto - Diamon
Frisé
SP33

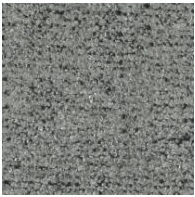

Tessuto - Diamon
Frisé
SP36



Tessuto - Diamon
Frisé
SP34



Tessuto - Diamon
Frisé
SP38



Tessuto - Baia
SP45



Tessuto - Baia
SP48



Tessuto - Baia
SP50



Tessuto - Baia
SP51



Tessuto - Baia
SP52



Fabric - Jurga
SP53



Fabric - Jurga
SP54



Fabric - Jurga
SP55



Fabric - Jurga
SP56



Fabric - Jurga
SP57

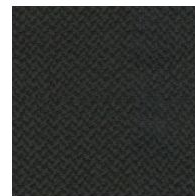

Fabric - Jurga
SP58

Tessuto - 800



Tessuto- Pastello
8D69



Fabric - Pastello
8D68



Fabric - Pastello
8D67



Fabric - Pastello
8D66



Fabric - Pastello
8D65



Fabric - Pastello
8D64



Fabric - Pastello
8D63



Fabric - Pastello
8D62



Fabric - Pastello
8D61



Fabric - Pastello
8D60



Fabric - Pastello
8D59



Fabric - Pastello
8D58



Fabric - Pastello
8D57



Fabric - Pastello
8D56

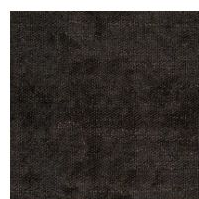

Fabric - Pastello
8D55



Fabric - Pastello
8D54



Fabric - Pastello
8D53



Fabric - Pastello
8D52

Tessuto - Class



Fabric - Hyle
EB55



Fabric - Hyle
EB56



Fabric - Hyle
EB57



Fabric - Hyle
EB58



Fabric - Hyle
EB59



Fabric - Hyle
EB60



Fabric - Hyle
EB61



Fabric - Hyle
EB62



Fabric - Hyle
EB63



Fabric - Hyle
EB64

PIEDI / BASE GIREVOLE

Metallo

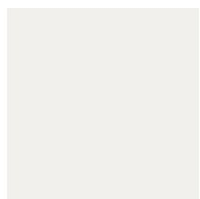

Metallo verniciato
Bianco opaco

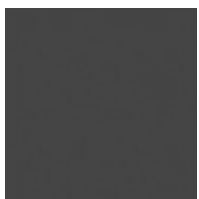

Metallo verniciato
Supreme anthracite

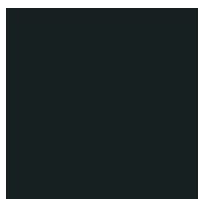

Metallo verniciato
Nero opaco



Metallo verniciato
Tortora opaco

Metallo Plus



Metallo verniciato
Bronzo opaco



Metallo verniciato
Piombo opaco



Metallo verniciato
Oro perlato opaco

Metallo Special

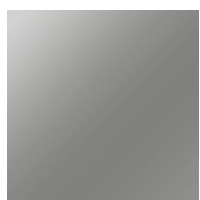

Metallo finitura
Clouded chrome



Metallo finitura
Brown nickel

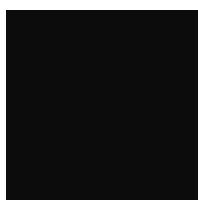

Metallo finitura
Dark nickel

Materiali, tessuti, colori e finiture sono puramente indicativi e possono variare da quelli attualmente rappresentati. Potete trovare la collezione completa di tessuti e pelli nel sito dedicato

