

→ PATRICK

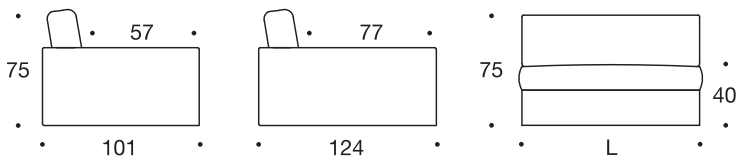

Dimensioni

Dimensions - Masse - Dimension - Tamaño



Schienale bracciolo con meccanismo

Arm/Backrest back with mechanism - Accoudoir/dos e avec mécanisme - Arm / Rückenlehne mit Mechanismus
Apoyabrazos/respaldo con mecanismo

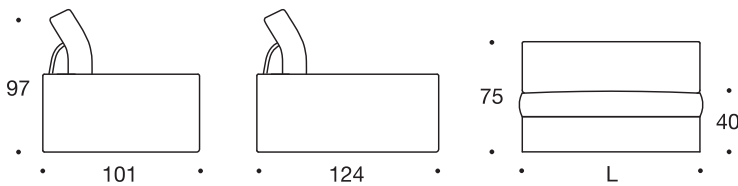

Cuciture optional

Sewings - Naehete - Coutures - Costuras



Chiusa
Closed
Feste Naht
Couture fermée
Costura cerrada

→ **PATRICK**

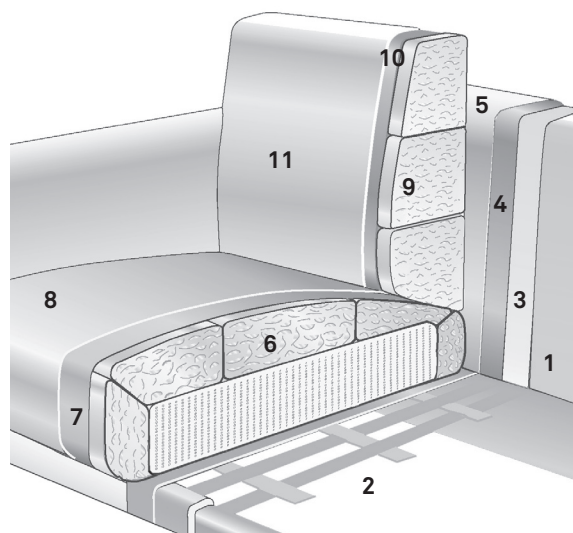

Struttura

Structure - Struktur
Structure - Estructura

1. Fusto legno

Wood structure - Structure en bois
Holzstruktur - Estructura de madera

2. Cinghia elastica

Belts - Elastische Gurte
Sangles élastiques - Correas elásticas

3. Gomma

Foam - Poliurethanschaum
Mousse - Poliuretano

4. Rivestimento

Cover - Bezug - Housse
Revestimiento

5. Tessuto sfoderabile

Removable fabric - Stoff déhoussable
Tissu abziehbar - Tela amovible

Cuscino seduta

Seat cushion - Sitzkissen
Coussin de siège - Cojín del asiento

6. Gomma quote differenziate con materassino in fibra acrilica cucita a scomparti

Foam in different densities with mattress in acrylic fiber sewn into compartments - Mousse de différentes densités avec matelas en fibre acrylique cousu dans des compartiments - Schaumstoff in verschiedenen Dichten mit in Kassetten genähter Matte aus Acrylfaser - Poliuretano en diferentes densidades con colchón de fibra acrílica cosida en compartimentos

7. Tela cotone bianco

White cotton linen - Tissu de coton blanc - Baumwolltuchstoff weiß
Algodón blanco

8. Tessuto sfoderabile

Removable fabric - Stoff déhoussable
Tissu abziehbar
Tela amovible

Cuscino schienale

Back cushion - Rueckenkissen
Coussins de dossier - Cojines de respaldo

9. Fibra acrilica cucita a scomparti

Acrylic fiber stitched into compartments - Fibre acrylique cousue dans des compartiments
In Kassetten genähte Acrylfaser
Fibra acrílica cosida en compartimentos

10. Tela cotone bianco

White cotton linen - Tissu de coton blanc - Baumwolltuchstoff weiß
Algodón blanco

11. Tessuto sfoderabile

Removable fabric - Stoff déhoussable
Tissu abziehbar - Tela amovible

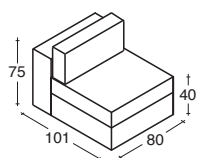
→ PATRICK

I101 Centrale 80x101
 Central element 80x101
 Élément central 80x101
 Mittelelement 80x101
 Elemento central



kg

 m³ 0,60

m 7,00

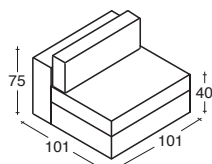

I102 Centrale 101x101
 Central element 101x101
 Élément central 101x101
 Mittelelement 101x101
 Elemento central



kg

 m³ 0,75

m 7,00

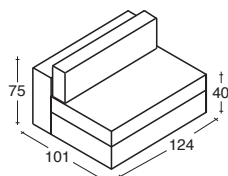

I103 Centrale 124x101
 Central element 124x101
 Élément central 124x101
 Mittelelement 124x101
 Elemento central



kg

 m³ 0,95

m 7,30

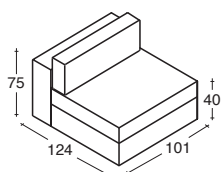

I104 Centrale 101x124
 Central element 101x124
 Élément central 101x124
 Mittelelement 101x124
 Elemento central



kg

 m³ 0,95

m 7,50

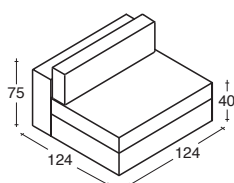

I105 Centrale 124x124
 Central element 124x124
 Élément central 124x124
 Mittelelement 124x124
 Elemento central 124x124



kg

 m³ 1,15

m 7,50

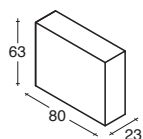

I106 Schienale bracciolo 23x80
 Backrest/armrest 23x80
 Dos/accoudoir 23x80
 Rückenlehne/Armlehne 23x80
 Respaldo/reposabrazo 23x80



kg

 m³ 0,12

m 2,00

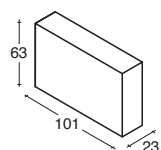

I107 Schienale bracciolo 23x101
 Backrest/armrest 23x101
 Dos/accoudoir 23x101
 Rückenlehne/Armlehne 23x101
 Respaldo/reposabrazo 23x101



kg

 m³ 0,15

m 2,00

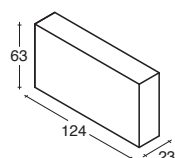

I108 Schienale bracciolo 23x124
 Backrest/armrest 23x124
 Dos/accoudoir 23x124
 Rückenlehne/Armlehne 23x124
 Respaldo/reposabrazo 23x124



kg

 m³ 0,18

m 2,00

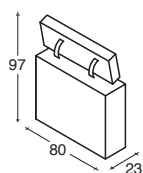
→ PATRICK

- I109 Schienale bracciolo con meccanismo 23x80**
 Backrest/armrest with mechanism 23x80
 Arm/Backrest back with mechanism 23x80
 Accoudoir/dos e avec mécanisme 23x80
 Arm / Rückenlehne mit Mechanismus 23x80
 Apoyabrazos/respaldo con mecanismo 23x80



kg

 m³ 0,35

m 3,50

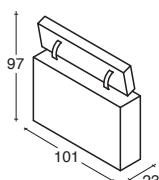

- I110 Schienale bracciolo con meccanismo 23x101**
 Backrest/armrest with mechanism 23x101
 Arm/Backrest back with mechanism 23x101
 Accoudoir/dos e avec mécanisme 23x101
 Arm / Rückenlehne mit Mechanismus 23x101
 Apoyabrazos/respaldo con mecanismo 23x8101



kg

 m³ 0,40

m 3,50

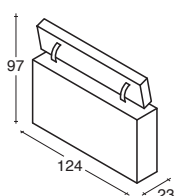

- I111 Schienale bracciolo con meccanismo 23x124**
 Backrest/armrest with mechanism 23x124
 Arm/Backrest back with mechanism 23x124
 Accoudoir/dos e avec mécanisme 23x124
 Arm / Rückenlehne mit Mechanismus 23x124
 Apoyabrazos/respaldo con mecanismo 23x8124



kg

 m³ 0,50

m 3,50

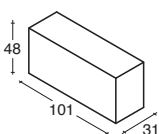

- I112 Bracciolo 31x101 H48**
 Armrest 31x101 H48
 Accoudoir 31x101 H48
 Armlehne 31x101 H48
 Reposabrazo 31x101 H48



kg

 m³ 0,15

m 2,00

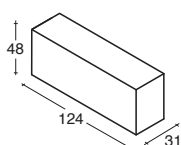

- I113 Bracciolo 31x124 H48**
 Armrest 31x124 H48
 Accoudoir 31x124 H48
 Armlehne 31x124 H48
 Reposabrazo 31x124 H48



kg

 m³ 0,18

m 2,00

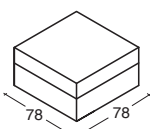

- I114 Base con seduta 78x78**
 Base with seat 78x78
 Base avec siège 78x78
 Basis mit Sitz 78x78
 Base con asiento 78x78



kg

 m³ 0,25

m 3,50

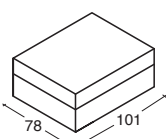

- I115 Base con seduta 78x101**
 Base with seat 78x101
 Base avec siège 78x101
 Basis mit Sitz 78x101
 Base con asiento 78x101



kg

 m³ 0,32

m 3,50

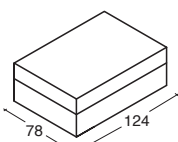

- I116 Base con seduta 78x124**
 Base with seat 78x124
 Base avec siège 78x124
 Basis mit Sitz 78x124
 Base con asiento 78x124



kg



 m³ 0,38

m 3,50

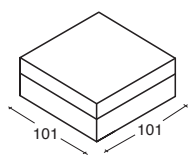
→ **PATRICK**

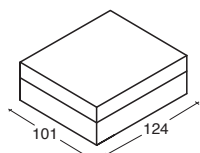

I117 **Base con seduta 101x101**
 Base with seat 101x101
 Base avec siège 101x101
 Basis mit Sitz 101x101
 Base con asiento 101x101



I118 **Base con seduta 101x124**
 Base with seat 101x124
 Base avec siège 101x124
 Basis mit Sitz 101x124
 Base con asiento 101x124

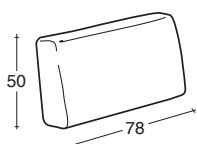

I119 **Cuscino schienale 78**
 Back cushion 78
 Coussin dossier 78
 Rückenkissen 78
 Cojín respaldo 78

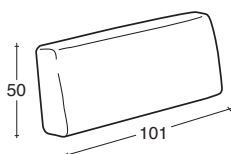

I120 **Cuscino schienale 101**
 Back cushion 101
 Coussin dossier 101
 Rückenkissen 101
 Cojín respaldo 101

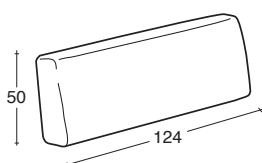

I121 **Cuscino schienale 124**
 Back cushion 124
 Coussin dossier 124
 Rückenkissen 124
 Cojín respaldo 124

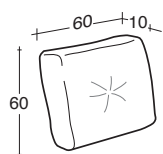

H839 **Cuscino schienale 60x60**
 Back cushion 60x60
 Coussin dossier 60x60
 Rückenkissen 60x60
 Cojín respaldo 60x60

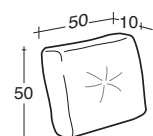

H840 **Cuscino schienale 50x50**
 Back cushion 50x50
 Coussin dossier 50x50
 Rückenkissen 50x50
 Cojín respaldo 50x50

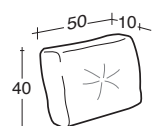

H841 **Cuscino schienale 50x40**
 Back cushion 50x40
 Coussin dossier 50x40
 Rückenkissen 50x40
 Cojín respaldo 50x40



→ **PATRICK**

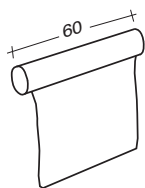

H842 Cilindro schienale 60
 Roller cushion cm 60
 Coussin à rouleaux cm 60
 Rollkissen cm 60
 cojín en forma de rollo cm 60



kg



m³ 0



m 1,00

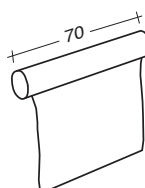

H843 Cilindro schienale 70
 Roller cushion cm 70
 Coussin à rouleaux cm 70
 Rollkissen cm 70
 cojín en forma de rollo cm 70



kg



m³ 0



m 1,00

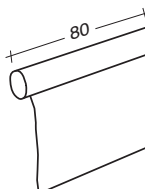

H844 Cilindro schienale 80
 Roller cushion cm 80
 Coussin à rouleaux cm 80
 Rollkissen cm 80
 cojín en forma de rollo cm 80



kg



m³ 0



m 1,00

→ **PATRICK**

C1 - Composizione - Composition - Composition - Gruppe - Composición

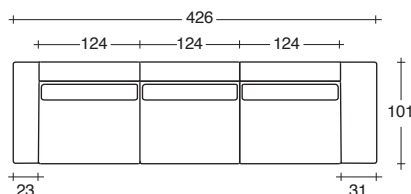

- 3-I116** Base con seduta 78x124
Base with seat 78x124
- 3-I108** Schienale/Bracciolo 23x124
Backrest/armrest 23x124
- 3-I121** Cuscino schienale 124
Back cushion 124
- I107** Schienale/Bracciolo 23x101
Backrest/armrest 23x101
- I112** Bracciolo 31x101 H48
Armrest 31x101 H48

C1A - Composizione - Composition - Composition - Gruppe - Composición

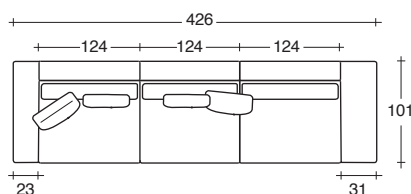

- | | |
|---|---|
| 3-I116 Base con seduta 78x124
Base with seat 78x124 | I112 Bracciolo 31x101 H48
Armrest 31x101 H48 |
| 3-I108 Schienale/Bracciolo 23x124
Backrest/armrest 23x124 | 2-H839 Cuscino schienale 60x60
Back cushion 60x60 |
| 3-I121 Cuscino schienale 124
Back cushion 124 | 2-H840 Cuscino schienale 50x50
Back cushion 50x50 |
| I107 Schienale/Bracciolo 23x101
Backrest/armrest 23x101 | |

C2 - Composizione - Composition - Composition - Gruppe - Composición

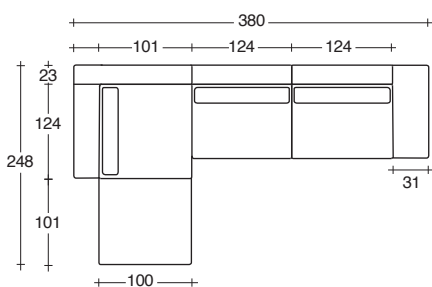

- | | |
|---|---|
| 3-I116 Base con seduta 78x124
Base with seat 78x124 | I107 Schienale/Bracciolo 23x101
Backrest/armrest 23x101 |
| 1-I117 Base con seduta 101x101
Base with seat 101x101 | I112 Bracciolo 31x101 H48
Armrest 31x101 H48 |
| 3-I108 Schienale/Bracciolo 23x124
Backrest/armrest 23x124 | |
| 3-I121 Cuscino schienale 124
Back cushion 124 | |

C2A - Composizione - Composition - Composition - Gruppe - Composición

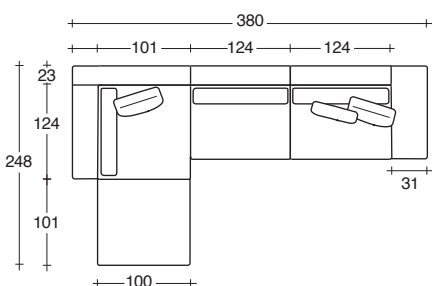

- | | |
|---|---|
| 3-I116 Base con seduta 78x124
Base with seat 78x124 | I107 Schienale/Bracciolo 23x101
Backrest/armrest 23x101 |
| 1-I117 Base con seduta 101x101
Base with seat 101x101 | I112 Bracciolo 31x101 H48
Armrest 31x101 H48 |
| 3-I108 Schienale/Bracciolo 23x124
Backrest/armrest 23x124 | 1-H839 Cuscino schienale 60x60
Back cushion 60x60 |
| 3-I121 Cuscino schienale 124
Back cushion 124 | 2-H840 Cuscino schienale 50x50
Back cushion 50x50 |

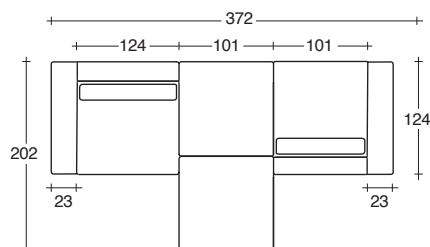
→ PATRICK
C3 - Composizione - Composition - Composition - Gruppe - Composición

- | | | | |
|---------------|--|-------------|--|
| 3-I117 | Base con seduta 101x101
Base with seat 101x101 | I120 | Cuscino schienale 101
Back cushion 101 |
| 1-I118 | Base con seduta 101x124
Base with seat 101x124 | I121 | Cuscino schienale 124
Back cushion 124 |
| 1-I107 | Schienale/Bracciolo 23x101
Backrest/armrest 23x101 | | |
| 3-I108 | Schienale/Bracciolo 23x124
Backrest/armrest 23x124 | | |

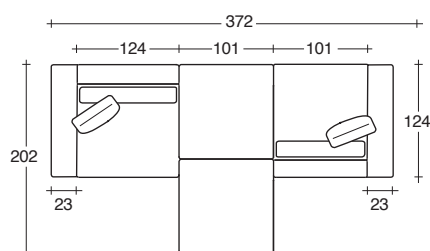
C3A - Composizione - Composition - Composition - Gruppe - Composición

- | | | | |
|---------------|--|---------------|--|
| 3-I117 | Base con seduta 101x101
Base with seat 101x101 | I120 | Cuscino schienale 101
Back cushion 101 |
| 1-I118 | Base con seduta 101x124
Base with seat 101x124 | I121 | Cuscino schienale 124
Back cushion 124 |
| 1-I107 | Schienale/Bracciolo 23x101
Backrest/armrest 23x101 | 2-H840 | Cuscino schienale 50x50
Back cushion 50x50 |
| 3-I108 | Schienale/Bracciolo 23x124
Backrest/armrest 23x124 | | |

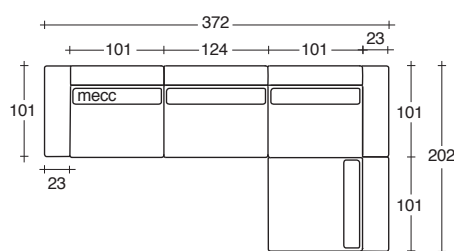
C4 - Composizione - Composition - Composition - Gruppe - Composición

- | | | | |
|---------------|--|---------------|--|
| 3-I115 | Base con seduta 78x101
Base with seat 78x101 | 2-I120 | Cuscino schienale 101
Back cushion 101 |
| 1-I116 | Base con seduta 78x124
Base with seat 78x124 | I121 | Cuscino schienale 124
Back cushion 124 |
| 1-I110 | Schienale/Bracciolo mecc. 23x101
Backrest/armrest 23x101 | | |
| 1-I108 | Schienale/Bracciolo 23x124
Backrest/armrest 23x124 | | |
| 4-I107 | Schienale/Bracciolo 23x101
Backrest/armrest 23x101 | | |

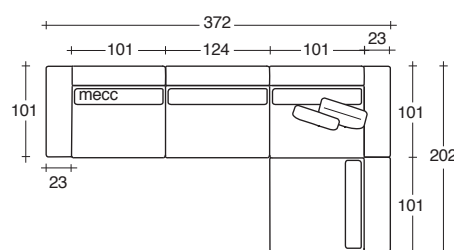
C4A - Composizione - Composition - Composition - Gruppe - Composición

- | | | | |
|---------------|--|---------------|--|
| 3-I115 | Base con seduta 78x101
Base with seat 78x101 | 2-I120 | Cuscino schienale 101
Back cushion 101 |
| 1-I116 | Base con seduta 78x124
Base with seat 78x124 | I121 | Cuscino schienale 124
Back cushion 124 |
| 1-I110 | Schienale/Bracciolo mecc. 23x101
Backrest/armrest 23x101 | H839 | Cuscino schienale 60x60
Back cushion 60x60 |
| 1-I108 | Schienale/Bracciolo 23x124
Backrest/armrest 23x124 | H840 | Cuscino schienale 50x50
Back cushion 50x50 |
| 4-I107 | Schienale/Bracciolo 23x101
Backrest/armrest 23x101 | | |

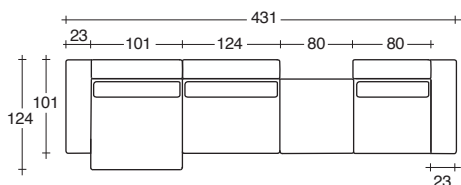
→ PATRICK
C5 - Composizione - Composition - Composition - Gruppe - Composición

- | | | | |
|---------------|--|---------------|--|
| 2-I114 | Base con seduta 78x78
Base with seat 78x78 | 1-I107 | Schienale/Bracciolo 23x101
Backrest/armrest 23x101 |
| 1-I117 | Base con seduta 101x101
Base with seat 101x101 | I119 | Cuscino schienale 78
Back cushion 78 |
| 1-I116 | Base con seduta 78x124
Base with seat 78x124 | I120 | Cuscino schienale 101
Back cushion 101 |
| 1-I108 | Schienale/Bracciolo 23x124
Backrest/armrest 23x124 | I121 | Cuscino schienale 124
Back cushion 124 |
| 1-I106 | Schienale/Bracciolo 23x80
Backrest/armrest 23x80 | | |

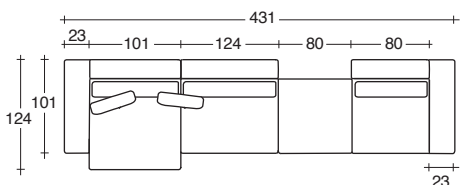
C5A - Composizione - Composition - Composition - Gruppe - Composición

- | | | | |
|---------------|--|---------------|--|
| 2-I114 | Base con seduta 78x78
Base with seat 78x78 | 1-I107 | Schienale/Bracciolo 23x101
Backrest/armrest 23x101 |
| 1-I117 | Base con seduta 101x101
Base with seat 101x101 | I119 | Cuscino schienale 78
Back cushion 78 |
| 1-I116 | Base con seduta 78x124
Base with seat 78x124 | I120 | Cuscino schienale 101
Back cushion 101 |
| 1-I108 | Schienale/Bracciolo 23x124
Backrest/armrest 23x124 | I121 | Cuscino schienale 124
Back cushion 124 |
| 1-I106 | Schienale/Bracciolo 23x80
Backrest/armrest 23x80 | 2-H840 | Cuscino schienale 50x50
Back cushion 50x50 |

Per tessuti e rivestimenti fare riferimento alla cartella - For fabrics and covers refer to the fabric folders