

ELADIO

ALLIEVI+VIGANÒ



Eladio è un letto accogliente in legno con testiera ammorbidita da cuscini che impiega l'uso di materiali basilari di valore: un progetto che nasce dal desiderio di creare una struttura rigorosa e coinvolgente nella sua forma morbida e poetica.

Struttura in massello di rovere. Cuscini testata in poliuretano espanso e materassina in piuma. Rivestimento sfoderabile in tessuto o pelle.

TIPOLOGIA / LETTI



DESIGNER

ALLIEVI & VIGANÒ

Alberto Viganò e Roberto Allievi studiano presso l'Istituto Statale d'Arte di Cantù, si laureano in Architettura al Politecnico di Milano. Nel 1993 fondano lo studio associato Allievi&Viganò. Lo studio si occupa di Architettura, Interior e Design. Numerosi sono gli interventi realizzati in Italia e all'Estero, molteplici le collaborazioni con le aziende leader del settore.



FINITURE STRUTTURA

ESSENZE OPACHE



50 Rovere
cenere

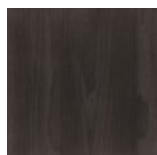

53 Olmo
grey

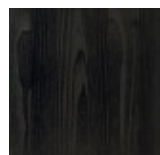

51 Rovere
nero

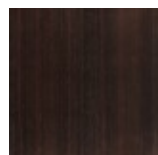

66 Tobacco

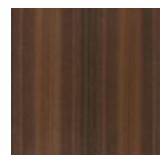

54 Eucalipto

FINITURE CUSCINATURE DI TESTATA

NODONE



A41 Sabbia

A47 Argilla

A48
Corteccia

A44 Muschio

A40 Carbone

A46 Roccia

A43 Ghiaia

A42 Sasso

JOJO



B41 Cicogna

B46 Fungo

B48 Radice

B4A Ghianda

B49
Scoiattolo

B47
Marmotta

B44 Lichene

B43 Ghio

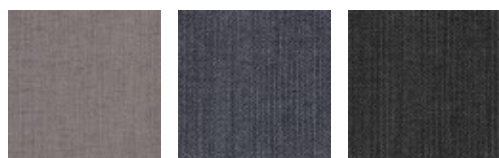

B45 Tortora

B42 Piccione

B40 Corvo

629



B61 White

B66 Beige

B69 Light
brown

B67 Taupè

B65 Brown

B68 Dark
brown

B62 Light
gray

B63 Blue

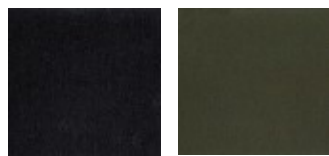

B60 Black

B64 Green

BARBAT



B31 Cigno

B36 Tortora

B37
Beccaccino

B34 Airone

B32 Ghio

B33 Piccione

B35 Riccio

B30 Corvo

TULSA



C82 Orso polare



C83 Airone



C85 Lepre



C88 Alpaca

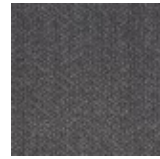

C86 Cervo



C81 Corvo



C87 Alligatore



C84 Squalo blu

M155



C91 Platino



C92 Argento



C90 Ferro



C93 Oro



C94 Bronzo

FUNKY



C70 White mix



C71 Rock mix



C7A Nuts mix



C78 Green mix



C76 Mustard mix



C77 Orange mix



C72 Brown mix

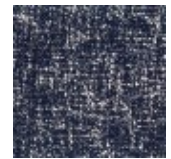

C79 Blue mix



C73 Iron mix



C74 Grey mix



C75 Black mix

ARTIDE



C20 Ecrù

BRERA



D31 Cigno

D36 Tortora

D37 Gufo

D34 Picchio
verde

D32 Airone

D35
Piccione

D33 Rondine

D30 Corvo

INDIANSKOP



D1B Sabbia

D1G Creta

D1F Betulla

D1C Sasso

D1D Roccia

D1A
Carbone

D1E Lichene

D1H Terra

TUNDRA



D2B Cigno

D2F Tortora

D2G Fungo

D2H Cicogna

D2L Ghianda

D2J Cervo

D2E Lichene

D2C Ghiro



D2D Lupo

D2K Talpa

D2A Corvo

FLYNN



D3B Rugiada

D3F Pietra

D3G Roccia

D3L Civetta

D3J Gufo

D3K Daino

D3E Muschio

D3H Guscio
di lumaca

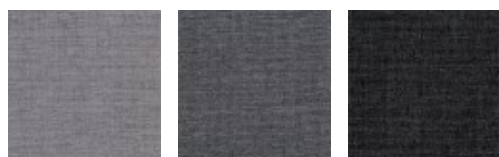

D3C Nebbia

D3D Pioggia

D3A Notte

GONG

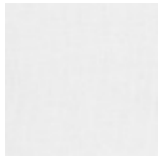

E61 Cigno



E67 Creta



E6C Lumaca

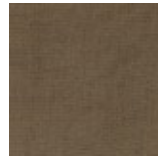

E68
Scoiattolo



E62 Airone



E65 Tortora



E6A Blu
fiume



E6B Talpa



E66 Riccio



E63 Passero



E69 Orso
bruno



E60 Rondine



E64 Felce

TADAO



E81 White
mix

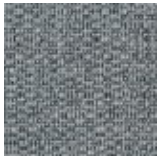

E85 Sand
mix



E83 Zaffiro
mix



E86 Snow
mix

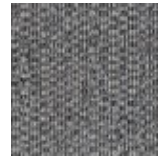

E88 Bronze
mix



E87
Cappuccino
mix

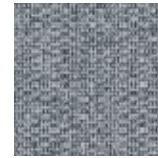

E82 Stone
mix

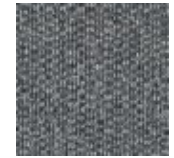

E80 Taupè
mix



E89 Rust mix

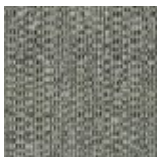

E84 Green
mix



E90 Sulfur
mix

YELLOWSTONE



E96 Rugiada



E99 Sabbia



E98 Terra



E95 Pietra



E97
Corteccia

GEMMA PLUS

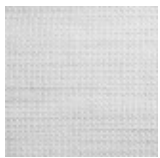

D54 Cigno



D59 Fungo



D61
Castagna



D65 Lumaca



D60
Nocciola



D57 Sotto
bosco

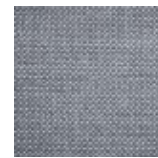

D55 Ghiro

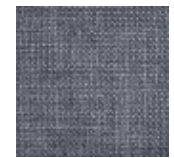

D56 Gufo



D73 Rondine

D66 Volpe

D58 Riccio

VELLUTO LARIO

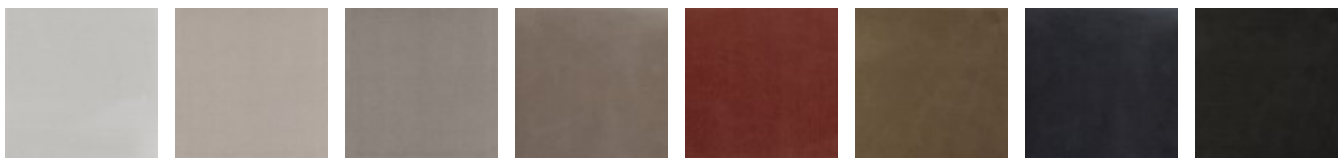

F33 Pietra

F56 Sabbia

F57 Tortora

F51
Scoiattolo

F54 Volpe

F55 Cervo

F35 Rondine

F53
Cortecchia

VELLUTO REGAL



F58 Mirtillo

F5A
Castagna

F59 Muschio

LUXUS

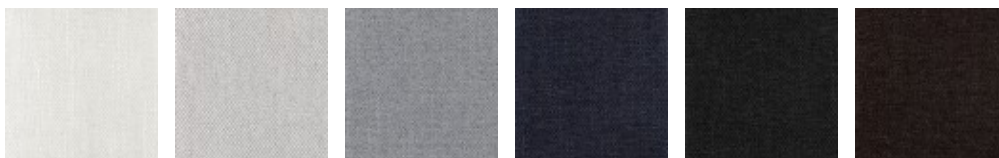

E50 Bianco

F01 Ecrù

F02 Grigio
perla

F05 Blu

F03 Lava

F04 Testa di
moro

GAUCHO



F28 Neve

F21 Nebbia

F29
Grandine

F20
Tempesta di
sabbia

F25 Solstizio

F26
Tramonto

F24 Acque
tropicali

F23 Nube



F27 Foresta

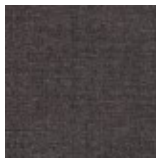

F22 Tornado

ORSETTO



H1B Perla

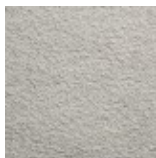

H1G
Conchiglia



H1H
Alabastro



H1C Opale

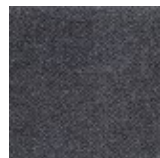

H1F Ematite

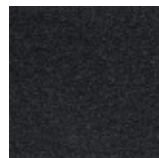

H1A Onice
nero

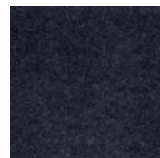

H1D Zaffiro

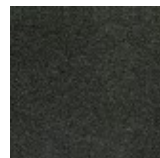

H1E Giada



H1J Agata

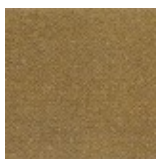

H1L Topazio

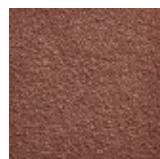

H1K Ambra

PELLI LISCE



H38 Sabbia

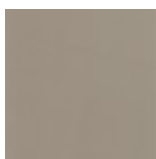

H36
Camoscio

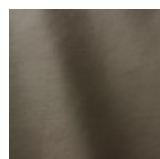

H3F Muschio

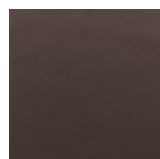

H71 Testa di
Moro



H3E Grigio
Caldo

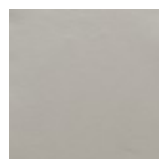

H35 Grigio
Chiaro

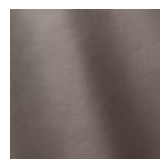

H08 Asfalto

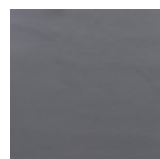

H26
Antracite

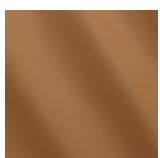

H3B Cuoio

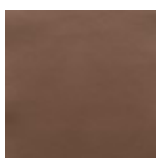

H31
Naturale

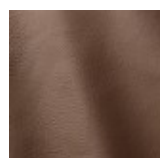

H3A
Terracotta

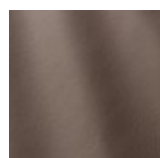

H34 Fango

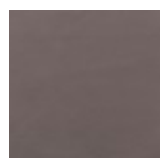

H32 Taupè

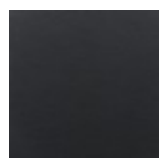

H73 Nero

PELLI NABUCCATE



HN3 Leone

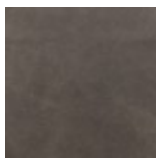

HN2
Rinoceronte

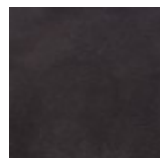

HN1 Orso
bruno

DIMENSIONI

Letto (materasso L. 1600 x P. 2000 mm)

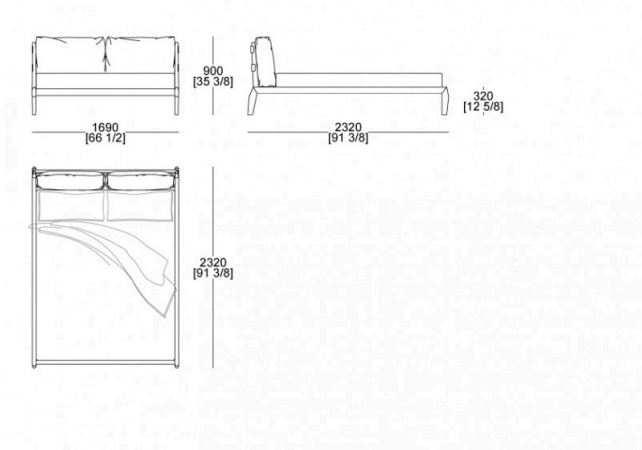

Letto (materasso L. 1800 x P. 2000 mm)

